

267-166

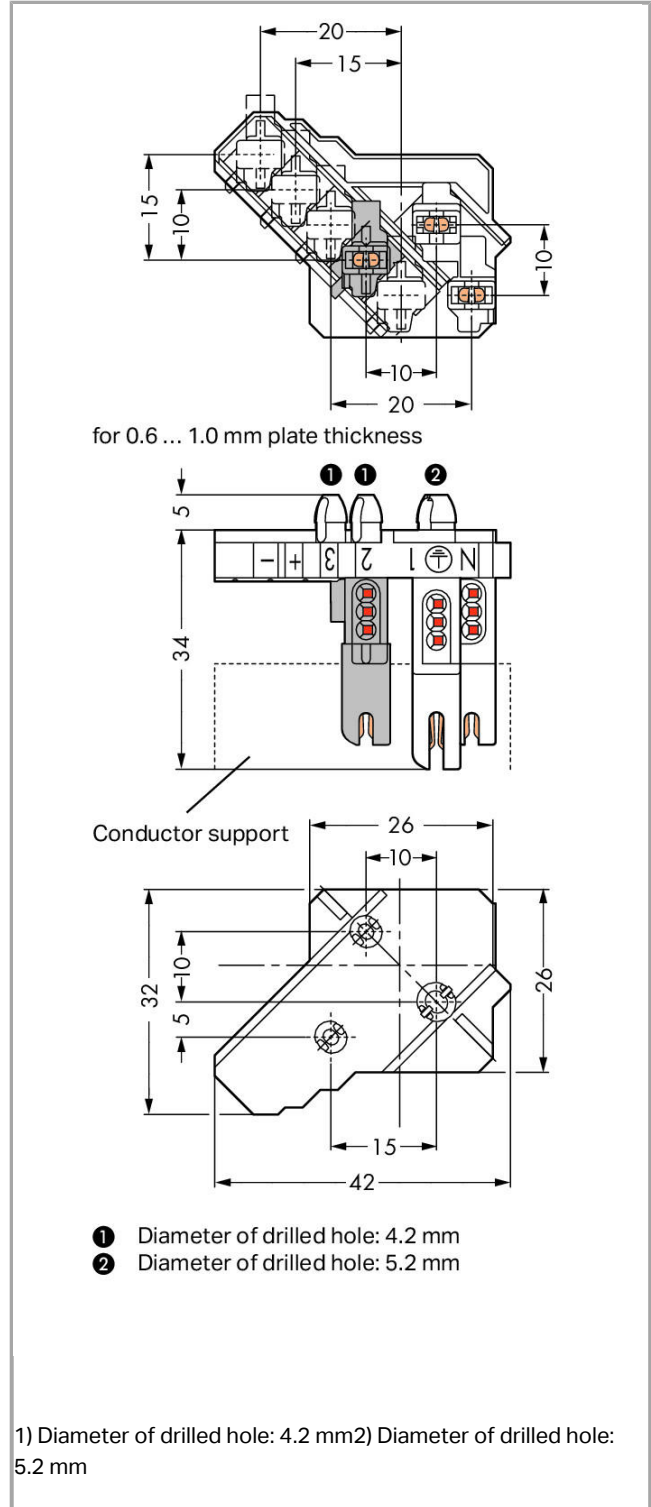
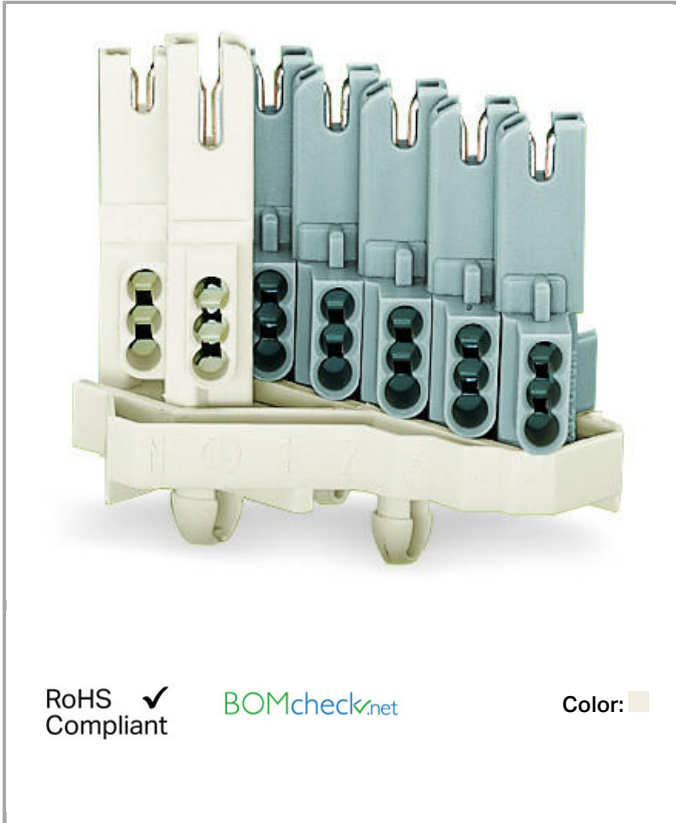

## Item description

- Flexible, modular 5- to 11-pole connector system
- Future system expansions possible
- Compact design

## Data

### Electrical data

#### Ratings per IEC/EN 60664-1

Rated voltage (III / 2)	500 V
Rated impulse voltage (III / 2)	4 kV
Rated current	6 A

### Connection data

Connection technology	PUSH WIRE®
Strip length	8 mm / 0.31 inch
Number of connection types	1
No. of poles	6

### Geometrical Data

Width	26 mm / 1.024 inch
Height from the surface	34 mm / 1.339 inch
Depth	42 mm / 1.654 inch

### Material Data

Color	white
Material group	I
Insulating material	Polyamide 66 (PA 66)
Flammability class per UL94	V0
Clamping spring material	Chrome nickel spring steel (CrNi)
Contact material	Electrolytic copper (E <sub>Cu</sub> )
Contact plating	tin-plated
Fire load	0.214 MJ
Weight	11.434 g

### Environmental Requirements



Temperature stability	105 °C
-----------------------	--------

## Commercial data



Product Group	8 (Misc. Chassis Mount Blocks)
Country of origin	PL
GTIN	4044918499712
Customs Tariff No.	8536901000

## Approvals / Certificates

### Radio-Approvals

Logo	Approval	Additional Approval Text	Certificate name
	CCA DEKRA Certification B.V.	EN 61984	NL-47718
	KEMA/KEUR DEKRA Certification B.V.	EN 61984	71- 100641
	VDE VDE Prüf- und Zertifizierungsinstitut	EN 61984	40032309

### Country specific Approvals

Logo	Approval	Additional Approval Text	Certificate name
	CCA DEKRA Certification B.V.	EN 61984	NL-47718
	KEMA/KEUR DEKRA Certification B.V.	EN 61984	71- 100641
	VDE VDE Prüf- und Zertifizierungsinstitut	EN 61984	40032309

### UL-Approvals

Logo	Approval	Additional Approval Text	Certificate name
	UL Underwriters Laboratories Inc.	UL 1977	E45171- 20040225



**Downloads**

**Documentation**

**Additional Information**

Technical explanations	Apr 3, 2019	pdf 3.6 MB	Download
------------------------	-------------	---------------	----------

---

**CAD/CAE - Smart Data**

**CAD data**

3D Download 267-166	URL	Download
---------------------	-----	----------

---

**EPLAN**

EPLAN Data Portal	Download
-------------------	----------

---

Subject to changes.

---